

**USER'S GUIDE**  
Installation & Operation  
Instructions

**DCP PRO METER**  
**ELECTROMAGNETIC FLOW METER**  
**(DC PULSED)**



## INDEX

<b>Introduction</b>	<b>2</b>
<b>Identification</b>	<b>2</b>
<b>Application</b>	<b>2</b>
<b>Inspection</b>	<b>2</b>
<b>Damaged Parts</b>	<b>2</b>
<b>Theory of Operation</b>	<b>3</b>
<b>Description</b>	
<b>General</b>	<b>4</b>
<b>Meter Body</b>	<b>4</b>
<b>Electronics</b>	<b>4</b>
<b>Application Guidelines</b>	<b>5</b>
<b>Conductivity</b>	<b>6</b>
<b>Installation</b>	<b>6</b>
<b>Piping and Other Considerations</b>	<b>6</b>
<b>Installation Procedure</b>	<b>7</b>
<b>Electrical Connections</b>	<b>9</b>
<b>Output Functions</b>	<b>11</b>
<b>Start-up and Operation</b>	<b>13</b>
<b>Factory Calibration and programming</b>	<b>13</b>
<b>Calibration Coefficient</b>	<b>13</b>
<b>Re-calibration</b>	<b>13</b>
<b>Menu Organisation (DCP)</b>	<b>14</b>
<b>Troubleshooting</b>	<b>21</b>
<b>Testing of Flow</b>	<b>22</b>
<b>Specifications</b>	<b>23</b>
<b>Warranty</b>	<b>24</b>

## **General Information**

### **Introduction**

This manual covers the theory of operation, installation and field service procedures for SAFMAG electromagnetic flowmeters supplied with the DCP signal convertor. Should further support be required, contact your local representative or Flowmetrix SA directly.

### **Identification**

Before beginning installation of the SAFMAG flowmeter, verify that all parameters of the intended application match those of the flowmeter supplied.

### **Applications**

- Process control
- Pump protection
- Energy consumption and water conservation management

### **Inspection**

Upon delivery the packing case should be inspected for external damage. If damage is evident this fact must be reported to the carrier immediately and the case should only be unpacked with a representative of the shipping company present. Check the contents of the case against the packing slip.

### **Damaged Parts**

Damaged or defective parts should be returned to the supplier prepaid. Do not return goods until authorisation to do so have been obtained. Returned goods must have accompanying them a letter stating the following:

- Your company name and order number
- The contact person at your company
- Serial number and name of part
- Description of damage and cause if known
- Nature of any repair attempted by the user
- Type of repair, replacement or adjustment requested

## SAFMAG Electromagnetic Flowmeter

### Theory of Operation

The operation of an electromagnetic flowmeter is explained by reference to Faraday's law of electromagnetic induction. This law states that the voltage induced across an electrical conductor, as it moves at right angles through an electromagnetic field, is directly proportional to the velocity of that conductor through the field. Mathematically this statement is represented as shown below:

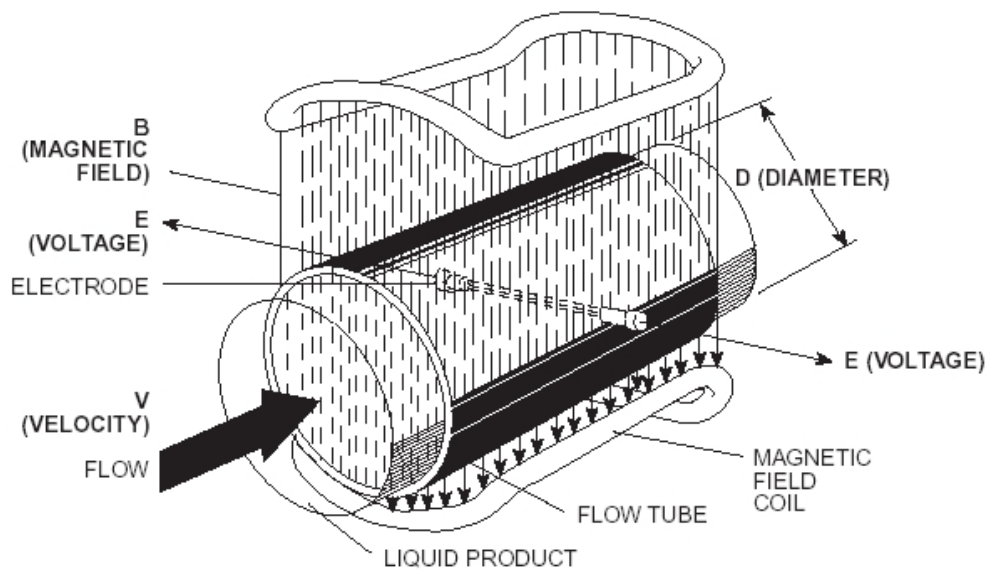

$$E = \text{constant} \times B L V$$

Where:

- E = the induced voltage
- B = the electromagnetic field strength
- L = the length of the conductor in the field
- V = the velocity of the conductor (average velocity of the medium)

The volumetric flow of a conducting liquid or slurry is derived as follows:

Let  $L = D$  (the diameter of the meter)  
Then,  $E = \text{constant} \times B D V$

Volumetric flow  $Q = V A$  (where A is the Cross-sectional area of the pipe)

Combining the above equations it is seen that if field strength is held constant then  $E = KQ$  (where K is a constant), thus the induced voltage is directly proportional to the volumetric flowrate.

## **Description**

### **General**

The SAFMAG DCP electromagnetic flowmeter is composed of two principle assemblies:  
The meter flow sensor, which is mounted in the pipeline  
The flowmeter signal converter, which is remotely or integrally mounted.

### **Flowtube (Sensor)**

The pipeline section, or flowtube, is lined with an insulating material compatible with the process liquid to be monitored. Two field coils are mounted on the flowtube, and these field coils generate the electromagnetic field inside the pipe section. As conductive liquid flows through this pipe section, a voltage is generated. In order to sense the voltage induced in the process fluid, electrodes are inserted through the lining and flowtube. These electrodes are chosen to be compatible with the process fluid.

### **Remote Electronics**

The SAFMAG DCP signal convertor provides pulsed DC coil excitation for the flowtube. Pulsed DC excitation is normally used when the process fluid is a pure liquid, the drive circuit in the electronics unit sending low-frequency pulses to the coils to generate the magnetic field.

Flowtubes with pulsed DC excited fields are not normally suitable for measuring the flow of slurries and pulp mixtures, and we recommend that the SAFMAG ACP AC excited magmeter is used for these applications.

In certain slurry applications, noise is generated as a result of particles impinging upon the electrodes, and the higher frequency and voltage of the AC excited magmeter offers a solution to these more difficult applications.

Paper stocks are more complicated, but the chemical additives found in various paper stocks make it difficult to predict accurately whether or not noise will be a problem.

The DCP utilises a multi-tasking microprocessor to handle all functions simultaneously. The Flowmetrix philosophy of producing easy-to-use instrumentation means that the unit can be programmed in a matter of minutes, even without the instruction manual. The flow rate and total are displayed continuously on a backlit LCD display, clearly visible through the viewing window in the cast aluminium housing.

### Application Guidelines

The minimum flow velocity through the SAFMAG DCP magmeter at full scale (i.e. 20mA), should not be less than 1 metre/second. The meter diameter should therefore be selected accordingly.

The SAFMAG DCP electromagnetic flowmeter has a minimum full-scale velocity of 1 metre/second and a maximum full-scale velocity of 10 metres/second. Velocity is calculated from volumetric flowrate by using the following equation:

$$V = 1273.24 Q/D^2$$

Where: Q is the flowrate in litres/sec  
D is the nominal meter size in mm

The table below gives meter capacities for minimum and maximum full scale velocities, for all meter sizes

**Flow Rate Guide**

PIPE SIZE (mm)	PIPE SIZE (INCH)	FLOWRATE @ 1m/s (3ft/s)				FLOWRATE @ 10m/s (30ft/s)			
		(l/s)	m3/hr	ft3/s	gal(US)/s	(l/s)	m3/hr	ft3/s	gal(US)/s
10	3/8	0.079	0.28	0.003	0.02	0.79	2.8	0.03	0.2
15	5/8	0.18	0.65	0.006	0.048	1.8	6.5	0.06	0.48
25	1	0.5	1.8	0.02	0.13	5	18	0.18	1.32
40	1.6	1.25	4.5	0.04	0.33	12.5	45	0.44	3.30
50	2	2	7.2	0.07	0.53	20	72	0.71	5.28
65	2.6	3.3	11.9	0.12	0.87	33	118.8	1.17	8.72
80	3.2	5	18.0	0.18	1.32	50	180	1.77	13.2
100	4	8	28.8	0.28	2.11	80	288	2.83	21.1
125	5	12	43.2	0.42	3.17	120	432	4.24	31.7
150	6	18	64.8	0.64	4.75	180	648	6.36	47.5
200	8	31	111.6	1.09	8.19	310	1116	10.95	81.9
250	10	49	176.4	1.73	12.9	490	1764	17.30	129.4
300	12	70	252.0	2.47	18.5	700	2520	24.72	184.9
350	14	96	345.6	3.39	25.4	960	3456	33.90	253.5
400	16	125	450.0	4.41	33.0	1250	4500	44.14	330.1
450	18	159	572.4	5.62	42.0	1590	5724	56.15	419.9
500	20	196	705.6	6.92	51.8	1960	7056	69.22	517.6
600	24	283	1018.8	9.99	74.7	2830	10188	99.94	747.4
700	28	385	1386.0	13.60	101.7	3850	13860	135.96	1016.8
750	30	442	1591.2	15.61	116.7	4420	15912	156.09	1167.3
800	32	500	1800.0	17.66	132.1	5000	18000	176.57	1320.5

## Conductivity

The first parameter to consider in deciding whether or not to use a magnetic flowmeter in a given application is conductivity. The conductivity unit of measure is microsiemens/cm or ( $\mu\text{S}/\text{cm}$ ). The minimum conductivity level for the SAFMAG DCP is  $20 \mu\text{S}/\text{cm}$ .

## Installation

### Piping and Other Considerations

The SAFMAG DCP electromagnetic flowmeter is a bi-directional device. The arrow on the flowmeter body indicates the direction of flow used during calibration at the factory, and the meter should be installed in the pipeline with the arrow in the direction of forward flow.

The meter may be installed in horizontal or vertical pipelines. If a vertical pipeline installation is envisaged the meter should be installed with the direction of flow being upwards, to ensure a **full** pipe under low flow conditions. If a horizontal installation is envisaged the meter electrodes should be installed in the horizontal plane in order to prevent entrained air or gasses creating a problem with the measurement.

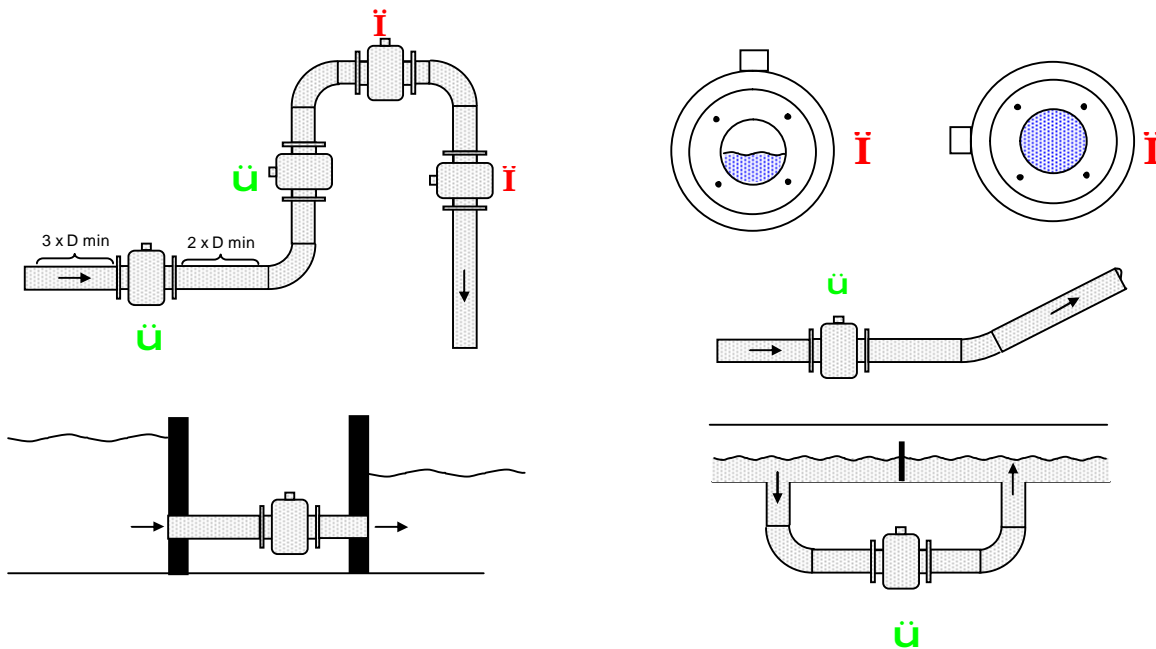

**It is essential that the meter be full of liquid at all times.**

If this is not the case then the meter will produce an artificially high flowrate. If obtaining a full meter is a problem, in some cases this may be solved by repositioning the meter at the lowest point in a “U” shaped pipe section.

Stray electromagnetic or electrostatic fields of high intensity may have an effect on the meter reading. For this reason the meter should not be installed close to large electric motors, transformers, communications equipment etc.



**NB: To ensure accurate flow measurement, the magmeter should be installed with at least 3 pipe diameters of straight pipe upstream, and 2 pipe diameters downstream of the magmeter.**

## Meter Body

The flowmeter should be lifted by a rope sling being passed around the outside of the meter or, in the case of the large meters the lifting lugs should be used. Never pass a cable or beam through the flowtube for lifting purposes, as this will damage the flowtube liner and render the meter unusable. Do not support the meter by its case.

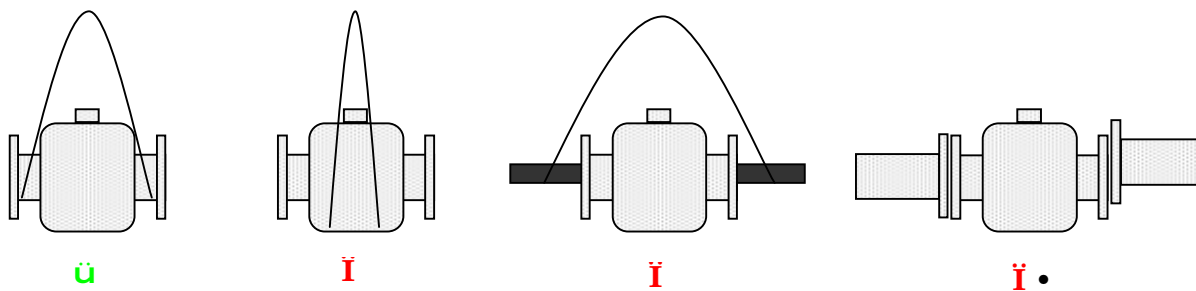

Check for alignment and spacing of pipework, as the meter should not be used to pull pipework into alignment.

Place flange gaskets on the flange faces of the meter and position the meter between the flange faces of the piping. Gaskets should be cut 3 mm larger than the inside diameter of the pipe.

Insert bolts through the flanges and run washers and nuts onto the bolts. Check the piping for alignment and the gaskets for concentricity. Tighten the nuts evenly – do not over tighten as this may damage the liner. Bolt torque should be limited to that which will produce a positive seal.

## DCP Signal Converter Installation

The signal convertor unit may be mounted up to 100 metres from the meter body. It should be mounted on the wall or a pipe stand using normal engineering procedures and safety procedures. **Exposure of the LCD to direct sunlight should be avoided.**



## Electrical Connections

The first rule to be observed is that the flowmeter body and the fluid should be at the same potential to ensure accurate measurement. Normally the grounding electrode in the flowtube or the metal pipeline ensures that the potentials are equalised. Certain installations however, require special consideration:

### Unlined metal pipelines (fig a)

In most installations where the flowtube is installed between the flanges of an unlined metal pipeline, the grounding electrode will be sufficient for accurate measurement. Where the process fluid has low conductivity, or if there is a possibility of induced currents in the pipeline, grounding rings and ground connections should be installed.

### Plastic or lined pipelines (fig b)

The grounding electrode will ensure accurate measurement on flowmeters up to 150 mm in size. Above 150 mm, additional precautions may be necessary, such as grounding rings.

**NB: Ensure the grounding rings are corrosion-resistant!**

### Pipelines with cathodic protection (fig c)

Pipelines with electric corrosion protection are generally insulated inside and outside so that the fluid has no conductive connection to ground. The flowtube must be insulated from the pipeline.

**NB: When installing the flowmeter, ensure that the grounding rings are insulated from the pipe flanges on both sides of the flowtube. Grounding rings, flowtube and measuring ground must be interconnected.**

Bypass the flowtube and the grounding rings with a conductor of sufficient current carrying capacity to pass the cathodic protection current with negligible voltage drop. Customer supplied grounding and connecting cables must have a cross section of  $6\text{mm}^2$  and be terminated with cable lugs.

SAFMAG Flowmeters require the use of a special cable supplied by FLOWMETRIX SA for the connections between the meter body and the remote electronics display. Refer to the connection diagram for details.

Normal electrical and safety practices should be followed when making the electrical connections.

**NB: AC supplies should not be run in the same cable as output signal. Screened cables should be used for all measurement signals.**

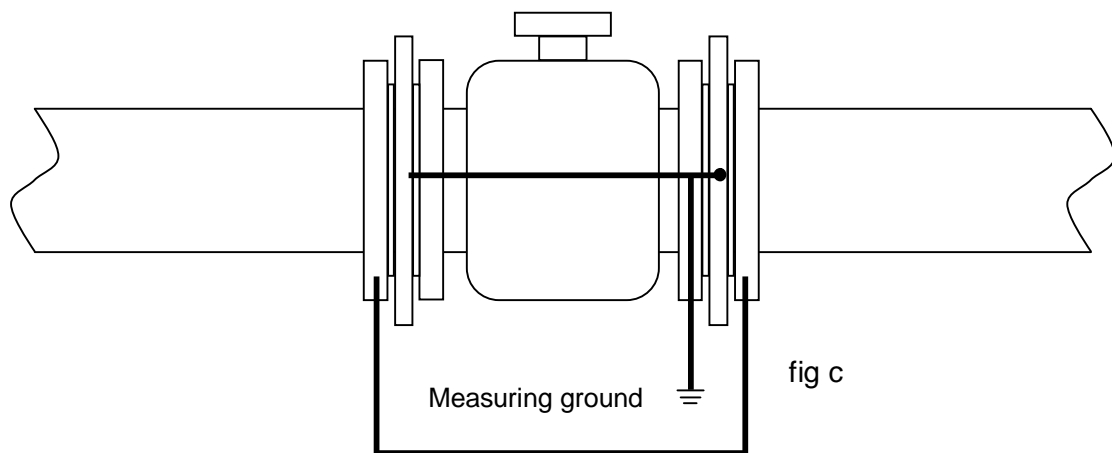
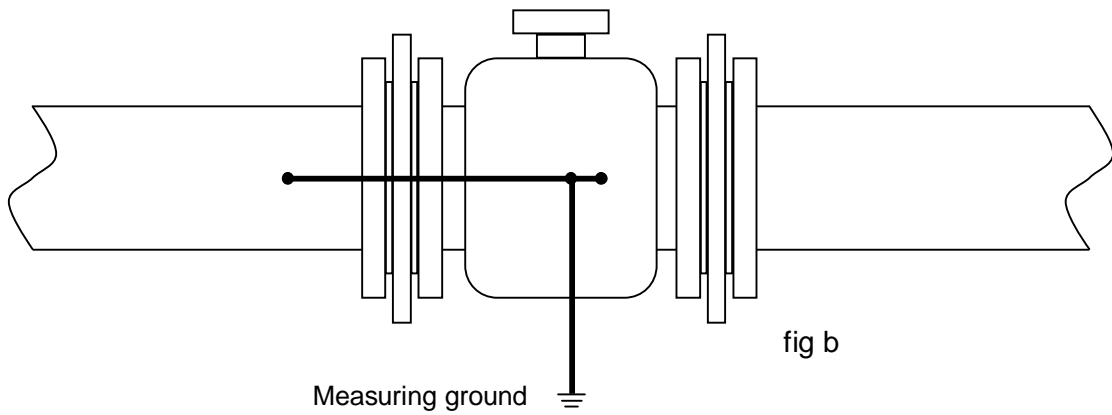
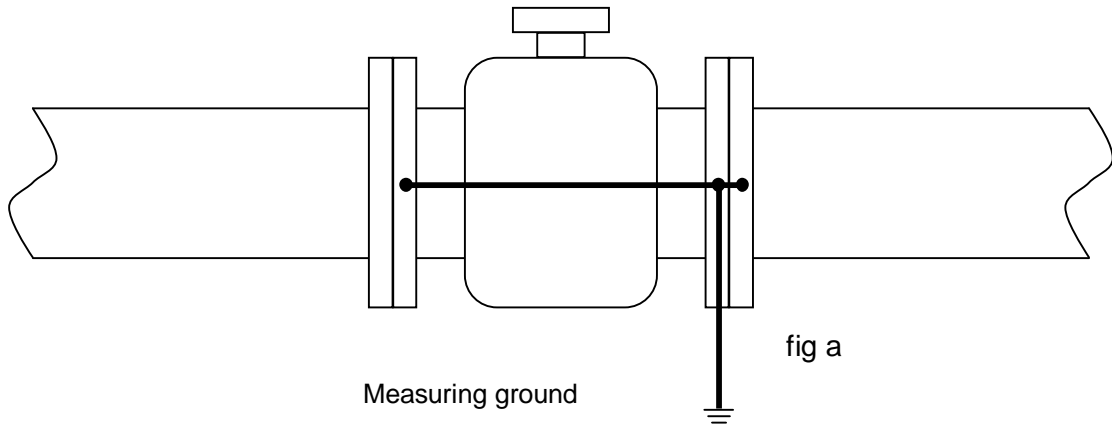

## Wiring Diagram

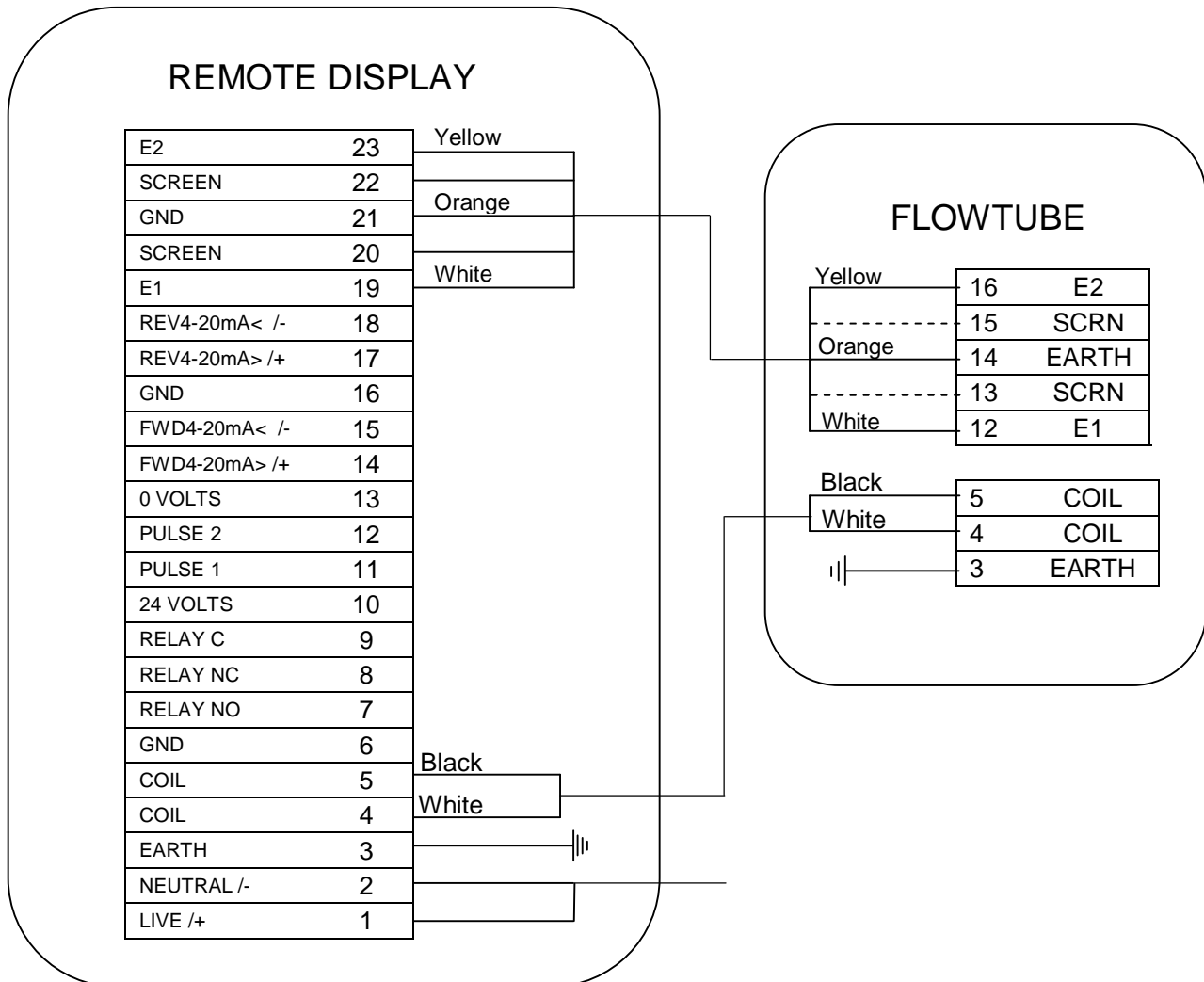

## Output Functions

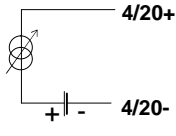
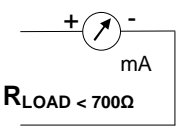
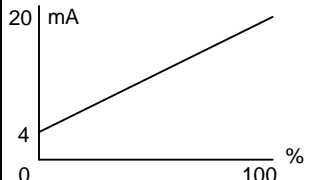

- The 4 – 20mA output signals are proportional to the flow rate. 4mA = 0 flow rate. The full-scale value (i.e. 20mA) is the flow rate figure programmed into menu item M1\_2 & M1\_3.

OUTPUT	DCP TERMINALS	EXT. CIRCUIT	SIGNAL
Flow rate Current Loop (Active)			

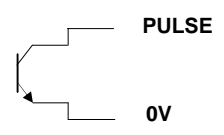
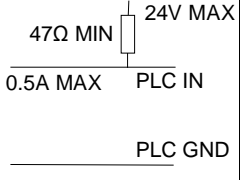
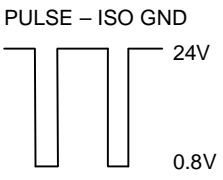
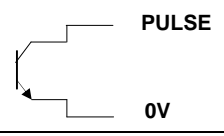
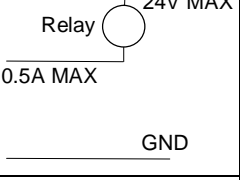
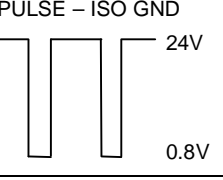
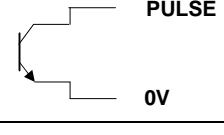
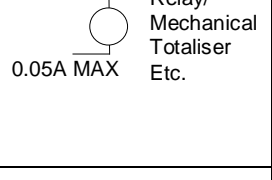
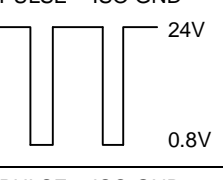
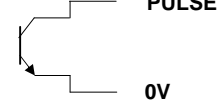
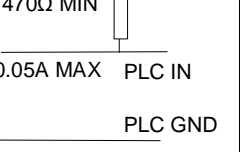
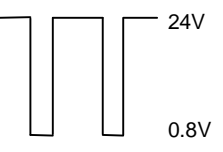
- The forward and reverse totaliser pulse output signal is either a 24V pulse available between the **24V** terminal and the **PULSE1 or PULSE 2** terminals, or an open collector output between **PULSE1 or PULSE 2** terminals and the **0V** terminal. The width of the pulse is selectable in menu item M2\_7, however if the pulse rate exceeds 1,33 pps, the pulse output will change to an output with equal mark-space ratio. M2\_6 is used to reduce the pulse output frequency.

<b>PULSE 1 or 2</b>			
OUTPUT	DCP TERMINALS	EXT. CIRCUIT	SIGNAL
Totaliser pulse Binary Output (Open-Collector) External supply and pull up resistor			
Totaliser pulse Binary Output (Open-Collector) External supply and relay/counter			
Totaliser pulse Binary Output (Open-Collector) Internal supply and relay/counter			
Totaliser pulse Binary Output (Open-Collector) Internal supply and external pull up resistor			

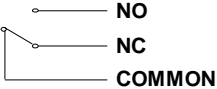
## Relay

OUTPUT	TERMINALS	EXT. CIRCUIT	SIGNAL
Relay Output	 <p>NO NC COMMON</p>	 <p>Relay Mechanical Totaliser Etc.</p>	<p>Relay NC/NO contacts Relay (220VAC – 0.27A, 24VDC – 2A)</p>

## Start-up and Operation

Before powering up the meter, consider the following:

- Is the meter installed according to the direction of flow as marked on the meter
- Has the wiring been carried out correctly and have all safety procedures been adhered to
- Is the supply voltage correct
- Has the flowmeter been properly earthed
- Lethal power supply voltages may be present, do not apply power with the electronics module cover or terminal box cover removed
- The SAFMAG is not suitable for installation in areas where explosive or flammable gas, vapour or dust is present.

To put the SAFMAG DCP into operation, allow the pipe work to fill with liquid. Purge all air from the pipe work and turn on the power. Allow time for the system to stabilise. With no flow, check that the flowmeter is reading zero, that the analog output is reading 4 mA, and that there is no pulse output.

Empty pipe detection is standard. When the converter detects high impedance in the electrode circuit, typically caused by an empty or partially filled pipe, a signal is sent to the microprocessor, which returns the flow reading to zero.

Although the empty pipe detection is standard, in some applications the conditions can create a situation where the flowmeter will still read intermittently, and **it is essential that for a trouble free installation the meter be full of liquid at all times.**

## CALIBRATION

### Factory Calibration and programming

Before despatch the signal converter has been programmed, either to the factory standard or to those specifications advised by the customer. The SAFMAG DCP electromagnetic flowmeter has been calibrated at FLOWMETRIX flow laboratory with direct traceability to the National Standards. The flowsensor will hold its stated accuracy indefinitely provided that it is correctly installed and undamaged. The signal converter can be verified using the DCP calibrator.

### Calibration Coefficient

Due to the design characteristics of the various SAFMAG flowmeters, each has its own calibration coefficient (k-factor). This coefficient is determined during the factory calibration, and will not change unless the flowtube is damaged.

### Re-Calibration

The SAFMAG DCP microprocessor signal converter has been designed for programming simplicity. The signal converters are interchangeable, and to re-calibrate a flowmeter the new parameters must be entered via the four push buttons.

All set-up requirements are contained in the menus, and each item is stepped to by pressing the **MENU** button.

**NB: The new data is only accepted if the 'save & exit' instruction is executed.**

### Menu Organisation (DCP)

With the SAFMAG DCP signal converter powered up flow total and flow rate are displayed

**+ 00000000 l**  
**à 5.986 l/s**

+ indicating Forward Total  
 à indicating Forward Flow

**- 00000000 l**  
**ß 5.986 l/s**

- indicating Negative Total  
 ß indicating Reverse Flow

**n 00000000 l**  
**à 5.986 l/s**

n indicating Nett Flow  
 ß indicating Reverse Flow

### Flow Menu

**Password?**  
 \* \* \* \*

Enter the required password. The flowmeter is shipped with the password 1000. (Default password = 1942). The signal converter set-up can be viewed without the password, however, no changes can be saved at the Save & exit menu and the error message “wrong password” is displayed.

Press ► repeatedly until cursor is under digit to be edited  
 Press ▲ repeatedly until desired value is displayed and **MENU** to continue

**Change?**  
**1000**

Providing the correct password was entered, a new password can now be entered. Enter the required password.

Press ► repeatedly until cursor is under digit to be edited  
 Press ▲ repeatedly until desired value is displayed  
 Press **MENU** to continue

**Units?**  
**Metric**

Selection of units of flow measurement  
 Press ▲ to select required units  
 Press **MENU** to continue to flow setting menus  
 The flowmeter settings are programmed via **Menu-1**, **Menu-2**, **Save & exit** and **Cal mode** (Calibration Mode)



### Batching Function

The SAFMAG DCP signal convertor can be programmed to operate as a simple batch controller. The option is selected under menu item **M1\_8**.

From normal run mode press **M**

<b>Batch?</b> <b>M-no</b> <b>S=yes</b>
---

Press **S** to enter the Batch Menu

<b>Batch Qty?</b> <b>1000</b> <b>m<sup>3</sup></b>
---

Use **▶** and **▲** to select Batch Quantity.

Press **S** to start, the external relay will now energise

<b>B 998</b> <b>m<sup>3</sup></b> =Remaining batch volume <b>50</b> <b>l/s</b> = Flow rate
---

In batch mode a **B** is displayed on the first line of the display, and as the batch proceeds, the batch quantity counts down until it reaches zero.

<b>B 0</b> <b>m<sup>3</sup></b> <b>end of batch</b>
--

At zero the relay is de-energised and an **end of batch** message is displayed.

### Restart Batch

Once end of batch is displayed press **S** to restart previous batch.

### Exit Batch

Once batch is complete press **M** to exit the batch mode.

Stopping the batch will de-energise the relay, but if flow continues the batch quantity will continue to count down.

<b>B -10</b> <b>m<sup>3</sup></b> <b>end of batch</b>
--

If flow continues the meter will continue counting, but will show a negative total, indicating the overrun.

<b>B 0</b> <b>m<sup>3</sup></b> <b>end of batch</b>
--

When the batch has finished, press **M** to return to normal run mode display,

## MENU-1 Flow Data

**Menu-1**  
**M-cont S-enter**

Press **SAVE** to enter or **MENU** to continue

**M1\_1 rate units**  
**l/s**

Press **▲** repeatedly until desired units are displayed and **MENU** to continue

**M1\_2 max flow**  
**à F 100 l/s**

Enter the maximum forward flow rate at which to output 20mA Fwd current

Press **▶** repeatedly until cursor is under digit to be edited

Press **▲** repeatedly until desired value is displayed and **MENU** to continue

**M1\_3 max flow**  
**∩R100 l/s**

Enter the maximum reverse flow rate at which to output 20mA Rev current

Press **▶** repeatedly until cursor is under digit to be edited

Press **▲** repeatedly until desired value is displayed and **MENU** to continue

**M1\_4 flow alarm**  
**20 l/s**

Enter the flow rate at which the flow alarm must operate

Press **▶** repeatedly until cursor is under digit to be edited

Press **▲** repeatedly until desired value is displayed and **MENU** to continue

**M1 -5 tot units**  
**m3**

Select the unit in which you wish to totalise

Press **▲** to select option required and **MENU** to continue

**M1\_6 total opts**  
**nett**

Select the total display option required

nett total – nett flow total continuously displayed

auto select – display automatically selected, forward total if there is forward flow and vice versa

scroll – display will scroll through the forward, reverse, and nett flow totals

Press **▲** to select option required and **MENU** to continue

**M1\_7 clr total?  
Save tot**

Select to clear or save the existing flow total  
Press ▲ to select option required and **MENU** to continue

**M1\_8 Batchmode?  
yes**

Select batch mode if required  
Press ▲ to select option and **MENU** to continue

**M1\_9 damping  
minimum**

Select minimum, medium, or maximum damping settings  
Press ▲ to select option required and **MENU** to continue

**M1\_10 cutoff  
2 %**

1%, 2%, 3%, 5% & 10% cutoff settings available  
Select the level below which the signal converter will output no flow  
Press ▲ to select option required and **MENU** to return to **Main Menu**

## MENU- 2 Setup Data

Menu-2  
M-cont S-enter

Press **SAVE** to enter or **MENU** to continue.

M2\_1 50/60Hz?  
50Hz operation

Select the AC power supply frequency  
Press **▲** to select and **MENU** to continue

M2\_2 dia mm  
100

Enter the nominal diameter of the flowmeter stamped on the flowtube.  
Press **▶** repeatedly until cursor is under digit to be edited  
Press **▲** repeatedly until desired value is displayed and **MENU** to continue

M2\_3 K-value  
1.023

Enter the calibration coefficient stamped on the flowtube  
Press **▶** repeatedly until cursor is under digit to be edited  
Press **▲** repeatedly until desired value is displayed and **MENU** to continue

M2\_4 sim% fwd mA  
100

The output current can be driven to any percentage of full scale by entering the desired value. This facility can be used for testing the mA loop and pulse output, the pulse output will be a constant 3Hz.  
Press **▶** repeatedly until cursor is under digit to be edited  
Press **▲** repeatedly until desired value is displayed and **MENU** to continue

M2\_5 sim% rev mA  
100

The output current can be driven to any percentage of full scale by entering the desired value. This facility can be used for testing the mA loop and pulse output, the pulse output will be a constant 3Hz.  
Press **▶** repeatedly until cursor is under digit to be edited  
Press **▲** repeatedly until desired value is displayed and **MENU** to continue

**M2\_6 puls-factor**  
**1.00 pulse/unit**

2 open collector pulse outputs are provided.

**Pulse1 output** has options for 4 modes of operation, and in addition a relay output. With “**pulse o/p**” option selected in **M2\_8 relay-opts**, the output pulse occurs each time the forward total increments.

**Pulse2 output** has no options available, and the output pulse occurs each time the reverse total increments.

Scaling of both the pulse outputs is provided by this menu item. 1.00, 0.10 & 0.01 pulse/unit options are available. The unit of flow is that selected in M1\_5.

Press **▲** to select and **MENU** to continue

**M2\_7 puls-width**  
**10ms**

Provided the output pulse rate is less than 3.125 pps, the width can be varied.

Press **▲** repeatedly until the desired value is displayed and **MENU** to continue

**NB:** the pulse output will change to a frequency with equal on-off period for a pulse rate >3.125Hz.

**M2\_8 relay-opts**  
**empty pipe**

There are 4 Pulse1 options available, which also operate the relay provided the relay link is inserted.

- 1) Pulse output – forward totalizer output
- 2) Reverse flow – detects change in flow direction
- 3) Flow alarm – detects high flowrate
- 4) Empty pipe – detects empty pipe condition

An isolated 24V supply is available at the output terminals limited to 30mA.

Press **▲** repeatedly until the desired option is displayed and **MENU** to return to **Main Menu**

**NB:** Pulse2 output is the reverse totalizer output for reverse flow total

**M2\_9 Slave add**  
**1**

This menu is only available in the units that are Profibus and Modbus capable.

Press **►** repeatedly until cursor is under digit to be edited.

Press **▲** repeatedly until the desired slave address is entered and **MENU** to continue.

## Cal Mode

To access the calibration menu enter the correct password and then press menu continuously until you reach Menu-2. **Hold MENU key depressed for 5 seconds and the Cal mode menu will appear.**

Entry to Cal mode is only possible if the correct password has been entered, and if the **MENU** key is held depressed at the correct time. (*see below*)

<b>Cal mode? S-enter</b>
------------------------------

This menu option is used to calibrate the 4-20mA outputs, It can also be used in conjunction with the **SAFMAG CALIBRATOR** to calibrate the signal converter. The calibration procedure is supplied with the calibrator.

### CAL MENU (hidden menu)

<b>M3_1 set fwd4mA 720</b>
--------------------------------

Connect an accurate milliamp meter to the current output terminals  
Select a value that drives the output to 4.00mA (approx. 720)  
Press ► repeatedly until cursor is under digit to be edited  
Press ▲ to select the output required and **MENU** to continue

<b>M3_2 set fwd20mA 3800</b>
----------------------------------

Connect an accurate milliamp meter to the current output terminals  
Select a value that drives the output to 20mA (approx. 3800)  
Press ► repeatedly until cursor is under digit to be edited  
Press ▲ repeatedly until desired value is displayed  
Press **MENU** to continue

<b>M3_3 set rev4mA 720</b>
--------------------------------

Refer M3\_1 above  
Press **MENU** to continue

<b>M3_4 set rev20mA 3800</b>
----------------------------------

Refer M3\_2 above  
Press **MENU** to scroll through Menu3 again, or **SAVE** to store values.

## Troubleshooting

Troubleshooting should be confined to establishing whether the fault lies in the flowtube assembly or in the signal convertor.

The information provided should assist in this.

The flowtube coils have a resistance of approximately 20Ωs.

All DC pulsed meters are supplied with the coils connected in series, giving a measured value of approximately 40Ωs at the terminals @ 20°C.

If the coil resistance differs from these values, it indicates a fault in the measuring head.

## Error / Warning Messages

ERROR MESSAGE	ERROR	POSSIBLE SOLUTION
# empty pipe	<ul style="list-style-type: none"> <li>No liquid in flowtube</li> <li>Faulty electrode / coil cable</li> </ul>	<ul style="list-style-type: none"> <li>Fill pipe</li> <li>Repair / replace cable</li> </ul>
# no coil current	<ul style="list-style-type: none"> <li>Faulty cable</li> <li>Faulty flowtube</li> </ul>	<ul style="list-style-type: none"> <li>Repair / replace cable</li> <li>Check coil resistance (should be approx. 40 ohms)</li> </ul>
# total error counts > 500 /s	<ul style="list-style-type: none"> <li>Totalizer count rate too high</li> </ul>	<ul style="list-style-type: none"> <li>Select more suitable total units</li> </ul>
# rate overflow	<ul style="list-style-type: none"> <li>Rate &gt; 999 999</li> </ul>	<ul style="list-style-type: none"> <li>Select more suitable rate units</li> </ul>

PROBLEM	POSSIBLE SOLUTION
<b><i>Meter not reading</i></b>	
<ul style="list-style-type: none"> <li>Reverse flow</li> <li>No flow</li> <li>Contaminated electrodes</li> <li>Leaking electrodes</li> </ul>	<ul style="list-style-type: none"> <li>Turn meter around or reverse coil wires</li> <li>Establish a flow</li> <li>Remove flowtube and clean electrodes</li> <li>Replace flowtube</li> </ul>
<b><i>Meter reading lower/higher than expected</i></b>	
<ul style="list-style-type: none"> <li>Incorrect data programmed</li> <li>Faulty display unit</li> <li>Leaking electrodes</li> </ul>	<ul style="list-style-type: none"> <li>Program correct data</li> <li>Replace display unit</li> <li>Replace flowtube</li> </ul>



## Testing of Flowtube

Always switch off power source before connecting and disconnecting cables.

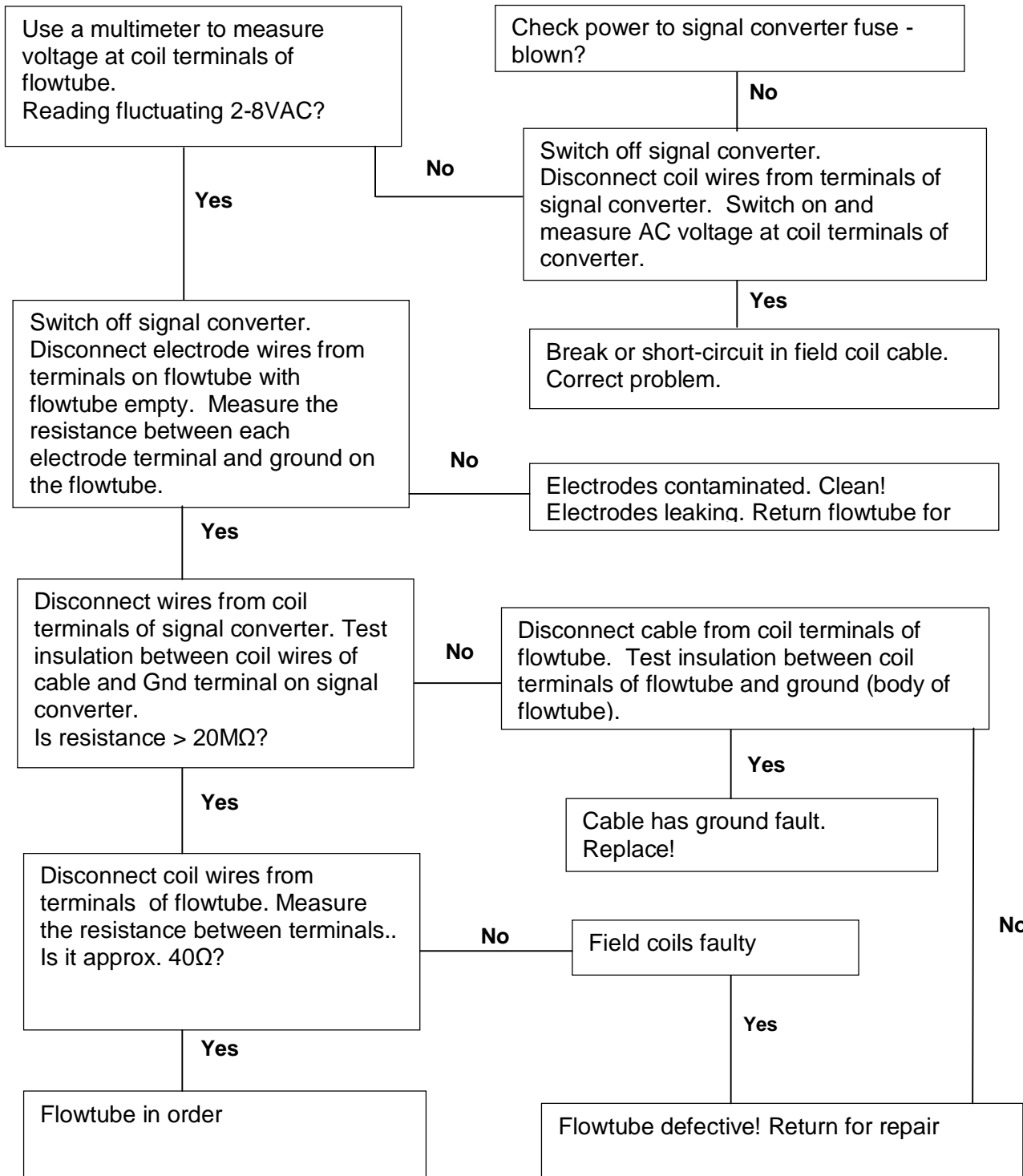

## Features & Specifications

<b>Velocity Range</b>	0.1-10 m/s (0.33-33ft/s)
<b>Accuracy</b>	Display and frequency output ± 0.5% of rate for velocity > 0.5m/s ± 0.025% of full scale for velocity < 0.5m/s
<b>Repeatability</b>	± 0.1 % of rate
<b>Sensor size</b>	25mm to 800mm (flanged format) PN10/16/25 IP67, IP68 (optional) 10mm to 150mm (wafer format) PN 16 IP67, IP68 (optional)
<b>Response time</b>	3 Selectable levels of damping
<b>Temperature limit</b>	Converter: -10 to 50°C
<b>Display</b>	Flow total and flow rate 2 - line backlit LCD display.
<b>Display Enclosure</b>	IP65 138 x 178 x 73mm
<b>Supply</b>	85V to 265V ac, 50 or 60Hz / 12-30VDC
<b>Outputs</b>	Two 4 - 20mA into 650Ω load each. (Isolated outputs). Two 24V active pulse outputs. Relay (220VAC – 0.27A, 24VDC – 2A)
<b>Units</b>	Rate units: m/s, l/s, l/m, l/hr, m <sup>3</sup> /s, m <sup>3</sup> /m, m <sup>3</sup> /hr, ft/s, ft <sup>3</sup> /s, ft <sup>3</sup> /m, ft <sup>3</sup> /hr, USgps, USgpm, USgph, USmgd Total units: cl, dl, ml, l, m <sup>3</sup> , MI, ft <sup>3</sup> , 103ft <sup>3</sup> , 106ft <sup>3</sup> , USG, 103USG, 106USG
<b>Configuration</b>	Supplied to customers spec or modified on site via easy to use menu structure and touch keypad
<b>Communication</b>	Profibus DP& Modbus (optional)
<b>Options</b>	GSM telemetry - Installation Kit (Bolt sets & gaskets) Grounding rings (for lined or nonconductive pipe)
<b>Features</b>	Low cost Non-intrusive No pressure loss No moving parts No maintenance Active empty pipe detection Integral spike suppression Password and tamper protection Error displays for easy diagnosis Easy to install Easy to use Batch function for Batch control
<b>Low flow cutoff</b>	Adjustable. Below value outputs are driven to zero

## **WARRANTY**

Flowmetrix SA CC warrants to the purchaser that the equipment to be delivered hereunder will be free from defects in materials, workmanship and title and will be of the kind and quality designated in the proposal.

The foregoing warranty is exclusive and in lieu of all other warranties whether expressed or implied including any warranty of merchantability or of fitness for a particular purpose.

Warranties other than the above will only be effective if written and signed by an officer of Flowmetrix SA CC

If within 1 (one) year from the date of delivery, the equipment delivered hereunder does not meet the warranties specified above, Flowmetrix SA CC shall thereupon correct such defects, at its sole discretion, either by repairing or by replacing the instrument in its entirety.

The costs of returning the equipment to Flowmetrix SA CC and for the repaired or replaced item being returned to the purchaser shall be for the account of the purchaser.

The liability of Flowmetrix SA CC is conditioned upon the equipment covered hereunder being handled, installed, operated, maintained, stored or used, as the case may be, in strict accordance with the written instructions or technical direction supplied by Flowmetrix SA CC, and is further conditioned upon the purchasers prompt written notice (within 30 days) to Flowmetrix SA CC of such defects.

Flowmetrix SA CC makes no warranties which extend to the items covered hereby due to improper handling, installation, operation, maintenance, storage or use; abnormal or undisclosed environmental conditions; or operating or use in an otherwise improper manner.

The liability of Flowmetrix SA CC to the purchaser, except as to title, arising out of the supplying of the equipment or its use, under this warranty article, shall not, in any case, exceed the cost of correcting defects in the equipment as herein provided and upon the expiration of the warranty described herein, all such warranty liability shall terminate. The foregoing shall constitute sole warranty remedy of the purchaser and the sole warranty liability of Flowmetrix SA CC.

### **Goods Return Procedure**

Damaged or defective equipment should be returned to the supplier prepaid. Do not return goods until written authorisation to do so has been obtained. Returned goods must have accompanying them a letter stating the following:

- Your company name and order number
- The contact person at your company
- Serial number and name of product
- Description of damage and cause if known
- Nature of any repair attempted by the user
- Type of repair, replacement or adjustment requested